

MULTI-FUNCTION PROCESS CALIBRATOR

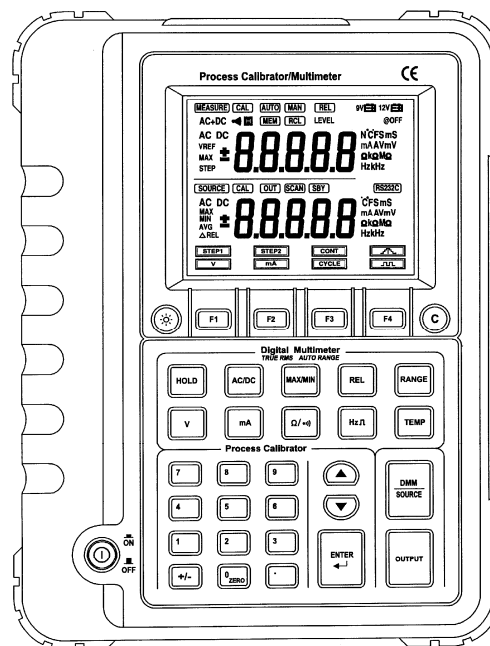

USERS MANUAL

CONTENTS

- Safety Precautions** 1
- Safety Information** 2
- Safety Symbols** 2
- General Description** 2
- Feature** 3
- Layout** 3
- Button Function Tour** 4
- LCD Display** 7
- Making Exporting** 9
 - Selecting Menu** 9
 - Source Output Map** 11
 - Volts Output** 12
 - Volts Output·DC Volts Output** 12
 - Volts Output·Step Volts Output** 13
 - Current Output** 16
 - Current Output ·DC Current Output** 17
 - Current Output·Step Current Output** 17

Frequency Output	19
Making Measuring	22
Measuring Volts	22
Measuring Current	23
Measuring Resistance, Continuity	24
Measuring Frequency	26
Measuring Temperature	27
Rs232 Data Interface	28
Backlight	28
Low Volts Indication	28
Replacing The Fuse	29
Replacing The Batteries	29
Specifications	30
General Specification	30
Accuracy and Resolution	31
Accessory	35
Others	35

Safety Precautions







- Read these operation instructions thoroughly and completely before operating your meter. Pay particular attention to WARNING. The instructions in these warnings must be followed.
- You must be careful when working with voltages above 30V AC. Keep fingers behind the probe barriers while measuring.
- Never use the meter to measure voltages that might exceed the allowable maximum input value of any function measurement mode.
- Always inspect your meter and test leads before every use. If any abnormal conditions exist: broken test leads, cracked cases, LCD not reading, etc, do not attempt to take any measurement.
- Using the meter with the equipped test leads is only conform to safety requirements. If you need instead broken test leads, you must replaced with the same as type and electric specification.
- Never replace the protective fuse inside the instrument with a fuse other than the specified or approved equal fuse. Replace only with same type of fuses. To avoid electrical shock, turn off the instrument and disconnect the test leads and any input signals before replacing the fuses.
- Never touch a voltage source when the test leads are plugged into a current jack.
- Do not expose the instrument to direct sunlight, extreme temperature or moisture.

READ THE INSTRUCTIONS BEFORE USING THE INSTRUMENT

Safety Information

Multi-function calibrator complies with IEC1010-1, Protection ClassIII , pollution degree 2 AC 300V. If the instrument is used in a manner not specified, the protection provided by the equipment may be impaired.

Safety Symbols

	Important safety information, see explanation in manual
	Dangerous voltage may be present
	Earth ground
	Equipment protected throughout by Double insulation or Reinforced insulation (Protection classII)
	AC (Alternating Current)
	DC (Direct Current)
	Battery

General Description

Multi-Function Process Calibrator is designed with exact current, voltage calibrator function and digital multimeter function, it is used for detecting and debugging automatic control equipment in industry scene. The instrument can self-calibrate, and have a set of PC Recording software to record measured data.

Feature

- 1 . Measurement V, mA, Frequency, Ω , Temperature, max count 4000.
- 2 . Source output of voltage, current, frequency with high accuracy, voltage and current can increase by degrees in 0 to 99 steps to output step voltage and step current.
- 3 . With PC photoelectricity interface and PC windows software to record data and export graph.
- 4 . With measurement function and source output function, double display to show and control.
- 5 . With 32 function button and numeric button , Source output can be set and modified directly by numeric button.
- 6 . Output Power:15V 25mA

Layout

1. RS232C Standard Interface
2. AC Adaptor Plug
3. LCD Display
4. Menu Function Button
5. Clear Button
- 6 . Measurement Function Button
- 7 . DMM Measurement /Source Output Selector Button
- 8 . Up/Down Selector Button

Press F3 button to setup CYCLE of step source.

(4 .)  F4 MENU BUTTON

Press F4 button to select STEP SOURCE mode or Frequency mode.

2.  CLEAR BUTTON

To clear the wrong input of the user.

3. MEASUREMENT FUNCTION BUTTONS

Measure V, mA, Ω , Hz, TEMPERATURE and change range, switch AC to DC.

(1 .)  HOLD BUTTON

Press  button to toggle in and out of the data Hold mode, except in the Min/Max Hold mode.

(2 .)  VOLT MEASUREMENT BUTTON

Press  button to measure voltage.



(3 .)  AC/DC SWITCH BUTTON 

Toggle between AC and DC mode, DC is the standard configuration. Every press  to switch one time.

(4 .)  MILLIAMP MEASUREMENT BUTTON

Press  button to measure Milliamp.

(5 .)  MAX/MIN BUTTON

Press  to display the maximum(“Max”) readings, press  again to display minimum(“Min”) readings.

(6 .)  Ohms, CONTINUITY MEASURENET BUTTON 

Press to  measure Ohm, press it again to continuity test.



(7 .)  RELATIVE MEASUREMENT BUTTON

Press  to measure relative value.

(8 .)  REQUENCY MEASUREMENT BUTTON

Press  to measure frequency.

(9 .)  RANGE BUTTON

Press  button to select the Manual Range mode.  Button is inactive in other mode except in Volts, Ohms measurement mode. When the instrument turn on, the LCD displays "AUTO" symbol, it is in autorange mode, press  in Volts or Ohms measurement mode, the LCD displays "MAN" symbol, the instrument enter manual mode. In the Manual Range mode, the range switch one time by every pressing.

(10 .)  BUTTON 便

Press  to measure temperature.

4.  **DMM MEASUREMENT FUNCTION/ SOURCE OUTPUT FUNCTION SELECTOR BUTTON**

Toggle between DMM Measurement Function and Source Output Function.

5. **SELECTOR BUTTON**  

Press this two buttons to setup parameter of source.

6.  **SOURCE OUTPUT BUTTON**

Press  button to export source that user has defined.

7.  **CONFIRM BUTTON**

Press  button to confirm the user's input value.

8.  POWER BUTTON 

Turn on or off the instrument.

9. NUMERIC BUTTON

For user input the numerical value into the instrument.

10 .  BACKLIGHT BUTTON

Turn ON or OFF the backlight. When the backlight is turned on over 5 seconds, it will auto turned off.

LCD Display

- 1 . Measurement symbol
- 2 . Buzzer symbol
- 3 . Calibration symbol
- 4 . Hold symbol
- 5 . Auto symbol
- 6 . Manual symbol
- 7 . Relative symbol
- 8 . 9V Battery symbol
- 9 . 12V Battery symbol
- 10 . Step unit (N), Temperature(°C),Time unit (S)

- 11 . Milliamps unit (mA), Volts unit (V, mV)
- 12 . Ohms unit (Ω ,k Ω)
- 13 . Frequency unit (Hz, kHz)
- 14 . RS232 interface symbol
- 15 . Temperature($^{\circ}$ C),Time unit (S)
- 16 . Milliamps unit (mA), Volts unit (V, mV)
- 17 . Ohms unit (Ω ,k Ω)
- 18 . Frequency unit (Hz, kHz)
- 19 . Step Source menu
- 20 . Frequency menu
- 21 . Cycle menu
- 22 . Count menu
- 23 . mA menu
- 24 . Export Source symbol
- 25 . Step Of Milliamp menu
- 26 . Calibration symbol
- 27 . Volts menu
- 28 . Step Of Volts menu
- 29 . Relative symbol

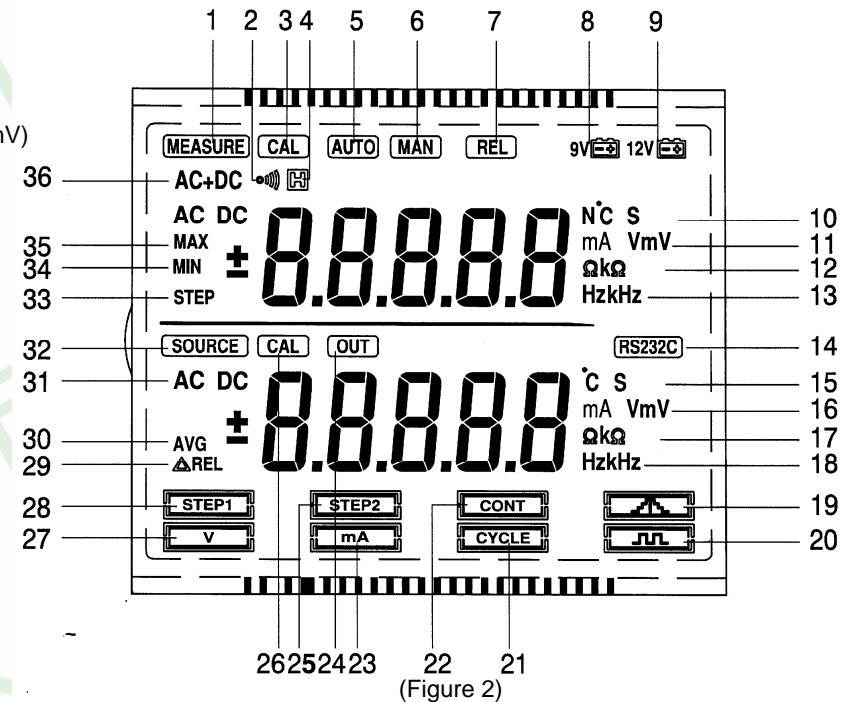

- 30 . Average symbol
- 31 . AC,DC symbol
- 32 . Source function symbol
- 33 . STEP symbol
- 34 . Minimum symbol
- 35 . Maximum symbol
- 36 . AC+DC symbol

Making Exporting

Selecting Menu

Turn the instrument on, the instrument auto enter DMM Measurement and Source Output mode, the LCD display shows as Figure 5, you can measure any circuit or set source parameter to export. Press  button in turn, the LCD display respectively shows MEASURE+SOURCE, MEASURE and SOURCE three menus. Selecting MEASURE is in DMM measurement mode, the instrument only can measure DMM; Selecting SOURCE indicates source output mode, so the instrument only can export source; MEASURE+SOURCE is in DMM measurement and source output mode, the instrument can measure any circuit and export source at the same time.

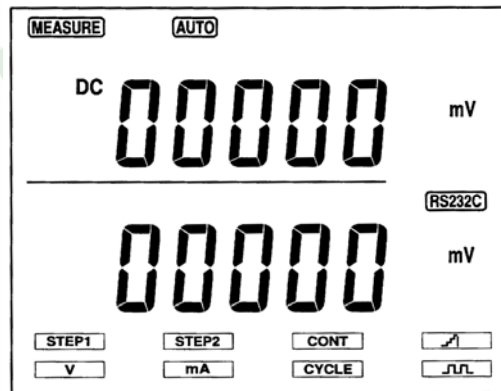

(Figure 3 : MEASURE Menu)

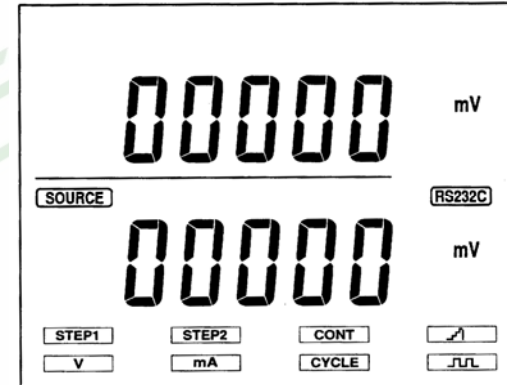

(Figure 4 : SOURCE Menu)

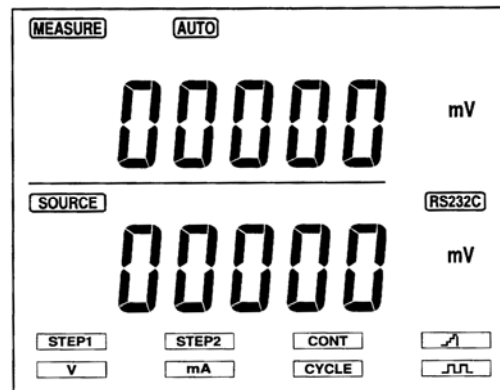

(Figure 5 : MEASURE+SOURCE Menu)

Source Output Map

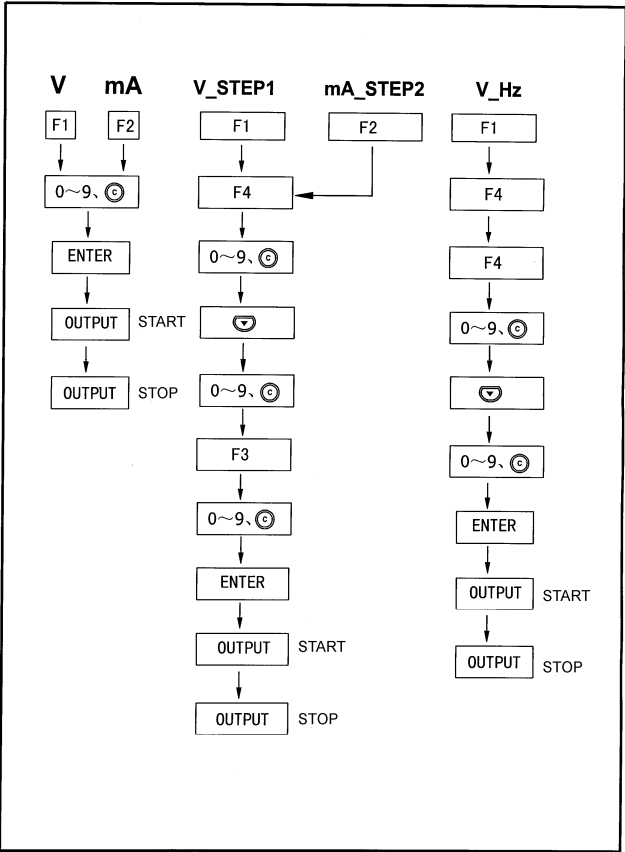

(Figure 6)

Volts Output



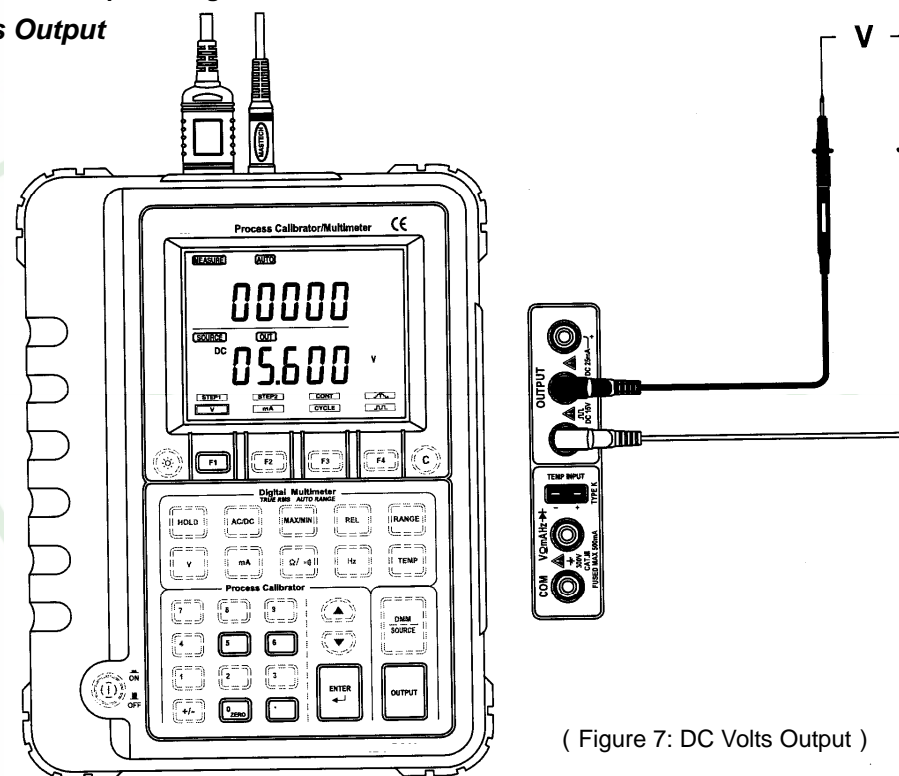

As volts source, the maximum output voltage is 15V.

Volts Output·DC Volts Output





(Figure 7: DC Volts Output)



Making Exporting Step Volts Output

- (1.) Connect the leads as shown: insert red lead into the red output terminal and insert black lead into the black output terminal. (as Figure 7)
- (2.) Press  to select Volts menu, the first bit of value is flashing on downside of the LCD display, press numeric key to set the value of Volts Source. For example, if you want to output 1.0V, then you press “1.0000” on the numeric key, and you can press  to clear wrong pressing; if you want to output in mV mode, after press  to select Volts menu, then press  the unit is changed to be “mV” on the LCD, press numeric key to input value in mV.

Select output in mV mode, when Source Volts value less than 100mV.

- (3.) Press  to confirm the setup, the LCD displays “01.000V “ again, then press , the LCD shows “01.000V” and “OUT” symbol. The instrument is outputting the set Volt value. For stop the source output, press  again, and “OUT” symbol disappears.

Volts Output-Step Volts Output

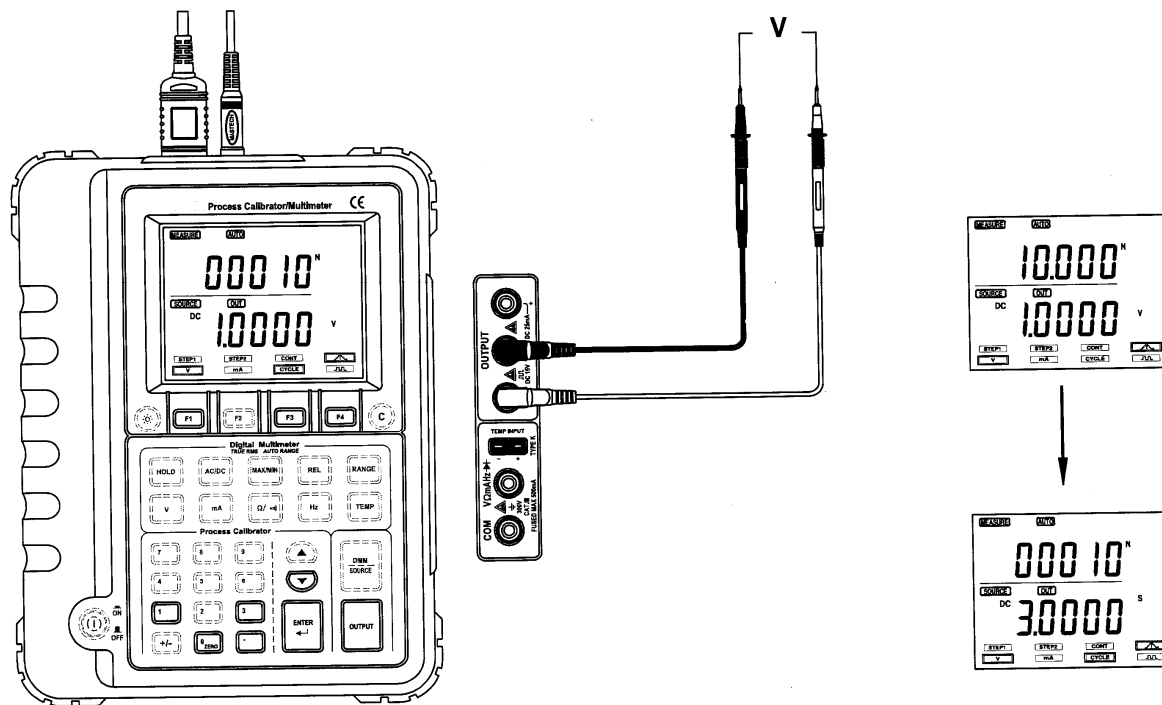

- (1.) Connect the red lead into red output terminal, and connect the black lead into black output terminal. (as Figure 8)
- (2.) Press  to select Volt menu, then press  to select Step Source menu. On the upside of the LCD you must set step length of Step Volts, The first bit of setting value is flashing, press numeric key to input desired value. For example, if step length need to be 10, then input “10.000” on the numeric key, and you can press  to clear wrong pressing.

Note: Maximum step length is 99 in the instrument , if your input above 99 , the instrument indicate error and need you set again.







(Figure 8 : Step Volts Output)

Making Exporting Step Volts Output

- (3 .) On the downside of the LCD you must set increment of Step Volts Source. After above procedure, press  button, the first bit of setting value is flashing, then press numeric key to input desired value. For example, if the increment of Step Volts Source will be set to 0.1V, then input "0.100".
- (4 .) Press  to select CYCLE menu, and the first bit of setting value is flashing on the downside of the LCD, press numeric key to input desired value. For example, Step Volts need gain a increment per two seconds, then you will input "2.000".

Note: Minimum value is 1s and maximum value is 99s in CYCLE.

- (5 .) Press  to confirm the set value, the LCD return to display "00000V".
- (6 .) Press  to export , the "OUT" symbol is shown on the LCD. Step Volt start to export from 0V and increase 0.1V per two seconds, count is 10 for increasing; when Step Volt increase to 1V, Step Volt output reset "0.0000V", and repeat above procedure to export Step Volt. For stop Step Volt Output, you can press  again, and "OUT" symbol is disappeared.
- (7 .) If Step Volt Source less than 100mV, then after press  in procedure (3), you also press  to change V mode into mV, so you can press numeric key to input desired value in mV, other operation is same as procedure (4) to (6) .
- (8 .) When Step Volts export in mV, if the result that Step Volts has completed all increment is above 100mV , the Step Volt only export 100mV continual until the count is over by step length, then the instrument return to 0.000mV again and step export circularly.

In this case, Step Volts Source is set in V not in mV.



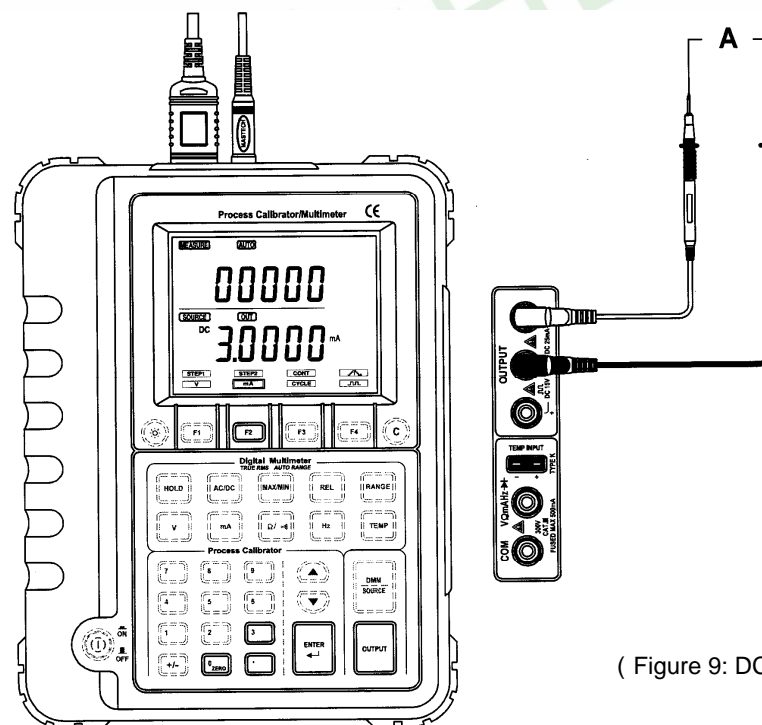

Current Output

As Source output, the Maximum output Current is 25mA.





(Figure 9: DC Current Output)

Current Output·DC Current Output

- (1.) Connect the leads as shown: insert red lead into the red output terminal of current and insert black lead into the black output terminal. (as Figure 9)
- (2.) Press  to select Current menu, the first bit of value is flashing on downside of the LCD display, press numeric key to set the value of Current Source. For example, if you want to output 3mA, then you press “3.0000” on the numeric key, and you can press  to clear wrong pressing;
- (3.) Press  to confirm the setup, the LCD displays “03.000 mA “ again.
- (4.) Press , the LCD shows “0.3000mA” and “OUT” symbol. The instrument is outputting the set Current value. For stop the source output, press  again, and “OUT” symbol disappears.

Current Output·Step Current Output

- (1.) Connect the red lead into red output terminal of current, and connect the black lead into black output terminal of the instrument. (as Figure 10)
- (2.) Press  to select Current menu, then press  to select Step Source menu. On the upside of the LCD you must set step length of Step Current. The first bit of setting value is flashing, press numeric key to input desired value. For example, if step length need to be 8, then input “8.0000” on the numeric key, and you can press  to clear wrong pressing.

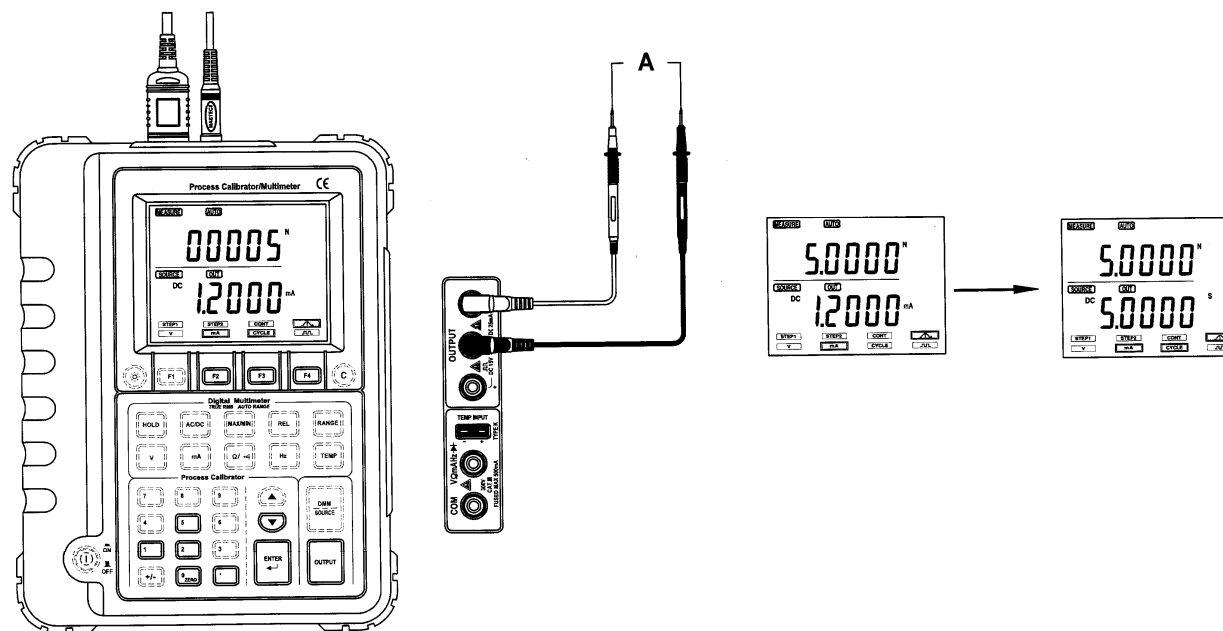

Note: Maximum step length is 99 in the instrument . if your input above 99 , the instrument indicate error and need you set again.

**Making Exporting
Step Current Output**





(Figure 10: Step Current Output)

Making Exporting Frequency Output



- (3.) On the downside of the LCD you must set increment of Step Current Source. After above procedure, press  button, the first bit of setting value is flashing, then press numeric key to input desired value. For example, if the increment of Step Current Source will be set to 1mA, then input "1.000".
- (4.) Press  to select CYCLE menu, and the first bit of setting value is flashing on the downside of the LCD, press numeric key to input desired value. For example, Step Current need gain a increment per three seconds, then you will input "3.000".

Note: Minimum value is 1s and maximum value is 99s in CYCLE.

- (5.) Press  to confirm the set value, the LCD return to display "00000mA".
- (6.) Press  to export, the "OUT" symbol is shown on the LCD. Step Current start to export from 0mA and increase 1mA per three seconds, count is 8 for increasing; when Step Current increase to 8mA, Step Current output reset "0.0000mA", and repeat above procedure to export Step Current. For stop Step Current Output, you can press  again, and "OUT" symbol is disappeared.

Frequency Output





As source output, the max output is 5000Hz in frequency.

- (1.) Insert red lead into red output terminal, and insert black lead into black output terminal.
- (2.) Press  to select Volt menu, and press  twice to select Frequency menu. Volt value is set on the upside of the LCD and frequency value of the Volt is set on the downside of the LCD. The first bit of Volts setting value, press numeric key to input desired value. For example, you want set 5V for Volt, then input "5.0000" on

Making Exporting Frequency Output

the numeric key. You can press  to clear wrong input. (as Figure 11)

Note: Volts only can be set in 5V, ±5V, ±15V, 15V in Frequency output mode.

- (3.) If you set Volt of frequency above 5V, the instrument will auto set in 15V, and if setting Volt value less than 5V, the Volt will be auto set in 5V. For ±5V or ±15V, before press numeric key you must press "+/-" button.
- (4.) Press , the first bit of frequency setting value is flashing on the downside of the LCD, press numeric key to input desired value of frequency. For example, setting value of output frequency is 60Hz, then input "60.000" on numeric key. Setting value of Frequency must be standard industry frequency. (Refer to following (7))
- (5.) Press  to confirm the set value, the LCD return to display "00.000V".
- (6.) Press  to export, "60Hz" and the "OUT" symbol is shown on the LCD. Step Current start to export on. For stop Step Current Output, you can press  again, and "OUT" symbol is disappeared.
- (7.) You can set Frequency value in following 18 standard value: 5kHz, 2500Hz, 2000Hz, 1250Hz, 1000Hz, 800Hz, 500Hz, 400Hz, 250Hz, 200Hz, 160Hz, 100Hz, 80Hz, 60Hz, 50Hz, 40Hz, 25Hz, 20Hz. If you set a arbitrary value for frequency not above standard value, then the instrument will auto select a frequency value which your setting value is nearest to standard value.

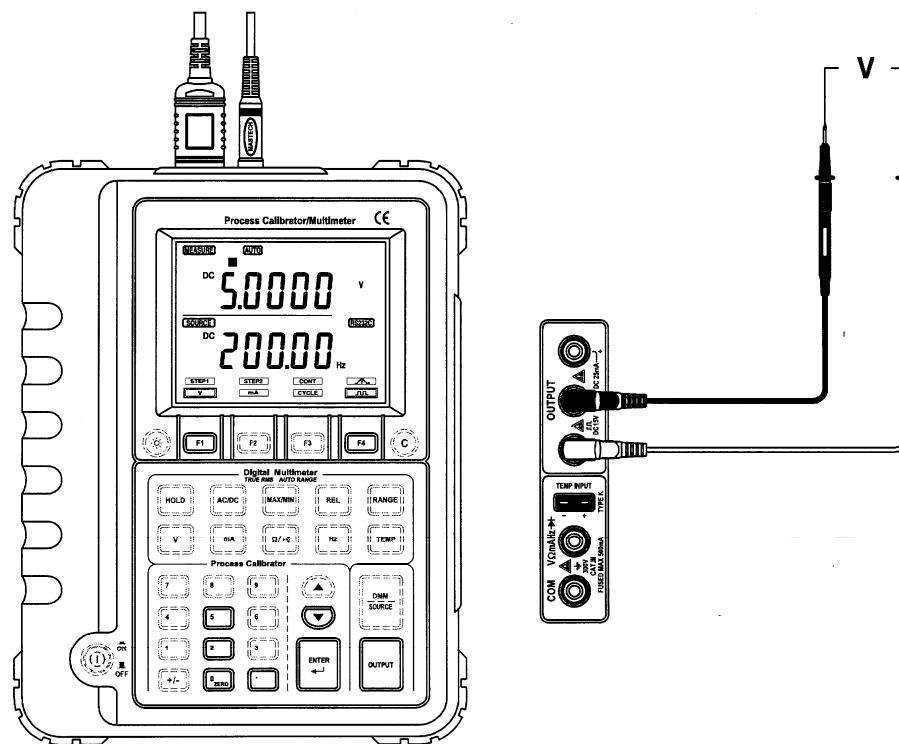

(Figure 11: Frequency Output)



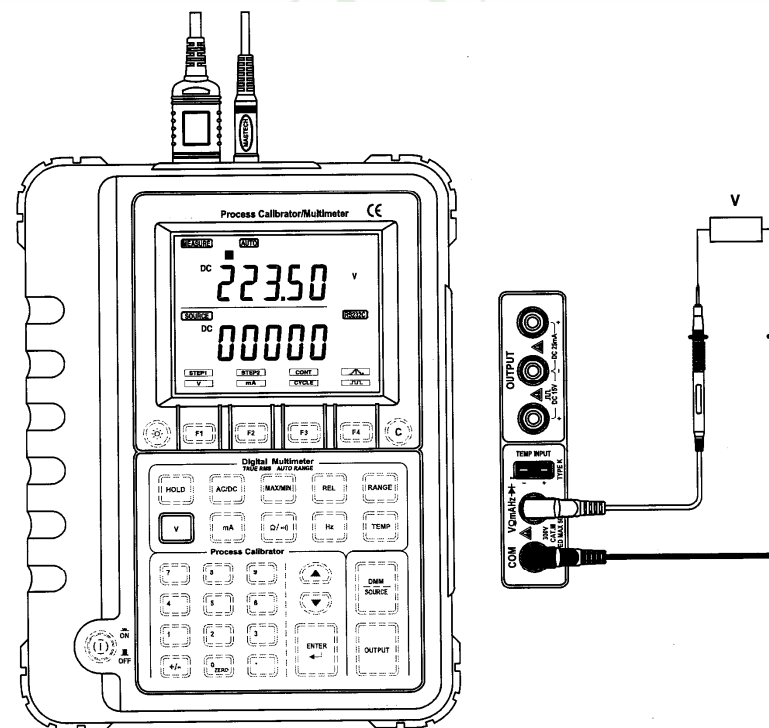

Making Measurements
Measuring Volts







(Figure 12: Measuring Volts)

Making Measurements

Measuring Current

1. Insert red lead into V Ω mAHz terminal, and insert black lead into COM terminal. (as Figure 12)
2. Press  to enter Volts Measurement mode, the Volts reading and its unit is shown on the upside of the LCD.
3. Press  the LCD displays "AC" symbol, the instrument is in AC mode now. Press this button again, the instrument displays "DC" symbol and enter DC measurement mode.
4. In Milliamp measurement mode, press  to measure maximum value in current circuit, press it again then the minimum value is shown.
5. For relative measurement, press  to get it.

Measuring Current

1. Insert red lead into V Ω mAHz terminal, and insert black lead into COM terminal. (as Figure 13) Press  to enter Milliamp Measurement mode, the current reading and unit is shown on the upside of the LCD.
2. Press , the LCD displays "AC" symbol, the instrument is in AC mode now. Press this button again, the instrument displays "DC" symbol and enter DC measurement mode.
3. In Milliamp measurement mode, press  to measure maximum value in current circuit, press it again then the minimum value is shown.
4. For relative measurement, press  to get it.

Making Measurements
Measuring Resistance, Continuity

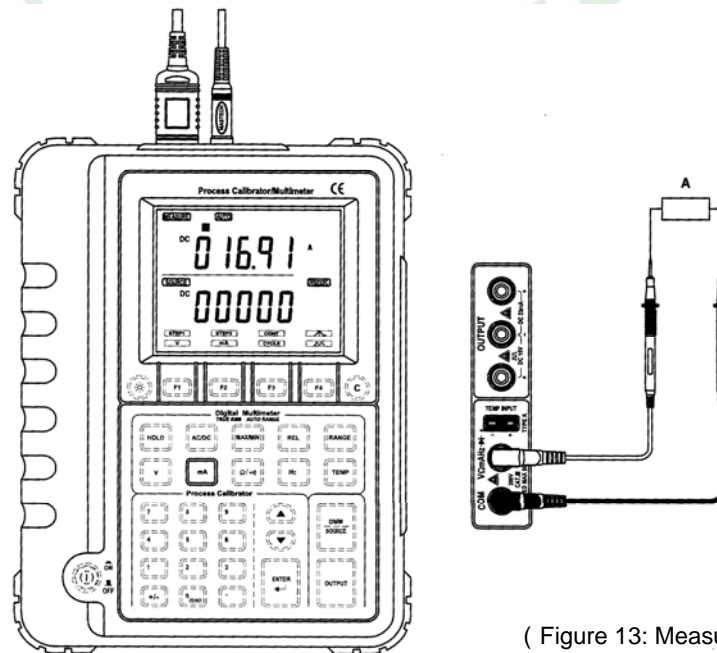



(Figure 13: Measuring Current)

Measuring Resistance, Continuity

- 1 . Insert red lead into V Ω mAHz terminal, and insert black lead into COM terminal. (as Figure 14) Press  to enter Resistance Measurement mode, resistance reading and the unit are shown on the upside of the LCD.

Making Measurements

Measuring Resistance, Continuity

2. In Resistance mode, the Maximum, Minimum, Relative measurement function is available by pressing  ,  .
3. Press  again, the Resistance Measurement mode is switched into Continuity.
4. Max measurement value is 400.00Ω in Continuity mode.

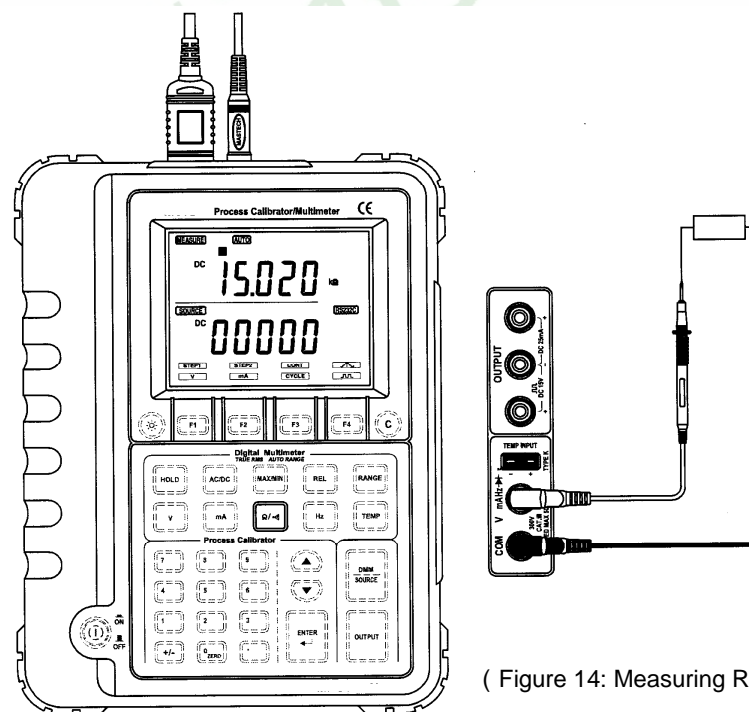

(Figure 14: Measuring Resistance, Continuity)

Measuring Frequency

- 1 . Insert red lead into V Ω mAHz terminal, and insert black lead into COM terminal. (as Figure 15)
- 2 . Press  to enter frequency measurement mode, then the reading is shown on the upside of the LCD.
- 3 . Maximum, Minimum, Relative measurement function is no available in frequency.

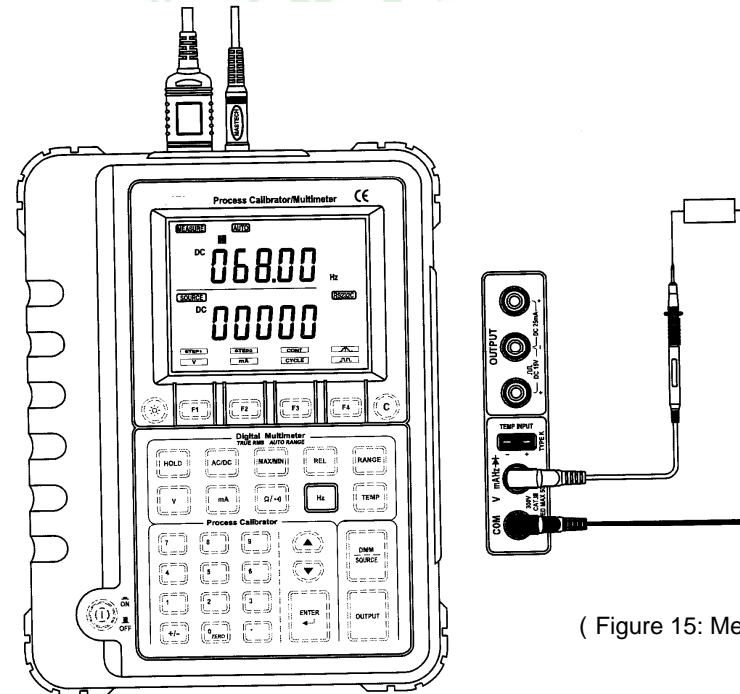

(Figure 15: Measuring Frequency)

Measuring Temperature

- 1 . Insert leads of the thermocouple into temperature measurement terminal as shown. (as Figure 16)
- 2 . Press  to enter temperature measurement mode, then the reading of current temperature is shown on the upside of the LCD.

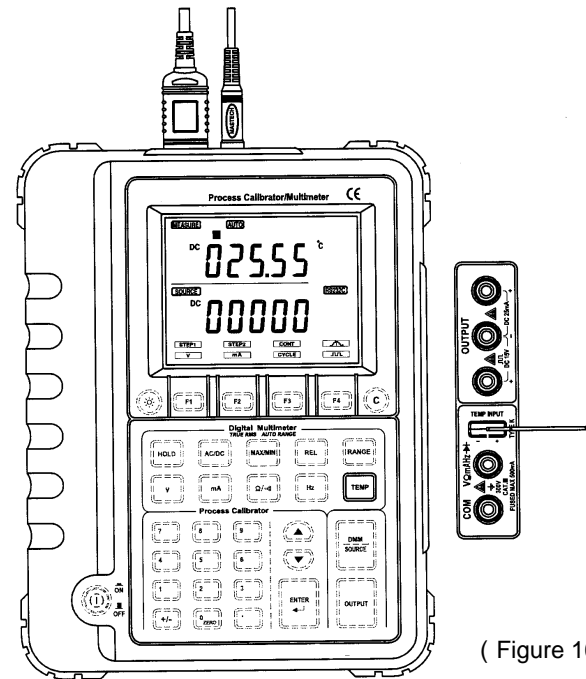

(Figure 16: Measuring Frequency)

RS232 Data Interface



The instrument can transmit data to PC computer by a RS232 infrared photoelectricity interface in real-time mode. You can connect the RS232 interface to a serial port of PC computer, then install the user data record software into the computer according to the README.TEXT file in the SETUP disk. After that, you can record and print the measured data of the instrument in real-time mode on the WINDOWS. The user data record special software can complete to record, collate, plot, print data in real-time mode.

Note: In all measurement mode, the measured data can be transmitted to the PC serial port automatically, but the instrument will stop transmitting in the SETUP mode.

Backlight

When you press the  button, the backlight turn ON. After about 8 seconds, the backlight auto turn OFF.

Low Voltage Indication

When the batteries are exhausted and the LCD displays the “9V ” symbol, you must replace new 9V Alkaline battery; If the LCD displays the “12V ” symbol, you must replace new 8 piece AA 1.5V batteries.

Note: Exhausted batteries and new batteries can be not used at the same time.

Replacing The Fuse

 **WARNING**

To avoid electrical shock, the instrument must be power off and disconnect the test leads or any input signals before replacing the fuses. Replace only with same type fuses. The input terminal is protected by a 100mA 250V fast blow ceramic fuse and 500mA 250V fast blow ceramic fuse.

Use the following procedure to replace the blown fuses of the instrument:

1. Disconnect test leads from the measured circuit, turn off the instrument, remove the test leads from input jacks.
2. Unscrew the screw on the back cover, and remove the battery cover.
3. Remove the blown fuse, replace with the same size and rating fuses.
4. The input terminal is protected by 100mA 250V fast blow ceramic fuse and 500mA 250V fast blow ceramic fuse.
5. Make sure the new fuse is centered in the fuse holder.
6. Reinstall the batteries cover and the screw.

Replacing The Batteries

 **WARNING**

To avoid electrical shock, the instrument must be power off and disconnect the test leads or any input signals before replacing the batteries. Never use the instrument unless the

back cover of the instrument is fastened completely. Replace only with same type or rating batteries.

When the LCD displays the “9V $\left[\text{battery symbol} \right]$ ” or “12V $\left[\text{battery symbol} \right]$ ” symbol, the batteries must be replaced to maintain proper operation.

Use the following procedure to replace the batteries:

1. Remove the test leads from tested circuit, turn off the instrument. Remove the test leads from the input jacks.
2. Unscrew the screw on the batteries cover and remove the cover.
3. Remove the exhausted battery and replace with new the same type or rating batteries.
4. Reinstall the battery cover and the screw.

Note: Exhausted batteries and new batteries can be not used at the same time.

Specifications

General Specification

- Display : Max 40000
- Range: autorange
- Overload indication: “OL” on the LCD
- Reading Holding: $\left[\text{HOLD symbol} \right]$ on the LCD
- Power Supply: AA 1.5Vx 8 piece and 9V Alkaline type one piece

Multi-Function Process Calibrator
Specifications

- Storage Temperature: -20°C ~ 70°C
- Operating Temperature: 0°C ~ 40°C
- Safety: Designed to ICE1010_1 300V CAT.III
- Dimension Size : 224mm×172mm×59mm
- Weight : approx. 1100g (include batteries)

Accuracy and Resolution

Accuracy is given as \pm (% of reading +number of least significant digits) at 18°C to 28°C,with humidity up to 80%

Measurement-DC Volts

RANGE	ACCURACY	RESOLUTION
400.00 mV	0.025%rdg+10d	0.01mV
4.0000 V	0.025%rdg+5d	0.1mV
40.000V	0.025%rdg+5d	1mV
300.00V	0.025%rdg+5d	10mV

Max Overload Voltage: 400V (RMS)

Multi-Function Process Calibrator
Specifications

Measurement-AC Volts

RMS

RANGE	ACCURACY	RESOLUTION
400.00mV	0.7%rdg+20d	0.01mV
4.0000V	0.8%rdg+10d	0.1mV
40.000V	0.8%rdg+10d	1mV
300.00V	0.8%rdg+10d	10mV

Max Overload Voltage: 400V (RMS)

Measurement-DC Current

RANGE	ACCURACY	RESOLUTION
400.00mA	0.1%rdg+10d	0.01mA

Overload Protection: 500mA/250V Fuse

Measurement-AC Current

RMS

RANGE	ACCURACY	RESOLUTION
400.00mA	0.7%rdg+10d	0.01mA

Overload Protection: 500mA/250V Fuse

Multi-Function Process Calibrator
Specifications

Measurement Resistance

RANGE	ACCURACY	RESOLUTION
400.00Ω	0.1%rdg+10d	0.01Ω
4.0000kΩ	0.1%rdg+10d	0.1Ω
40.000 kΩ	0.1%rdg+10d	1Ω
400.00 kΩ	0.1%rdg+10d	10Ω

Max Overload Voltage: 250V (RMS)

Measurement Frequency

RANGE	ACCURACY	RESOLUTION
4Hz ~ 999.9Hz	0.05	0.01Hz
100Hz ~ 5kHz	0.5Hz	0.01Hz ~ 0.1Hz
5kHz ~ 30kHz	2Hz	0.1Hz ~ 1Hz

Min Measurement Voltage: 50mV

Max Overload Voltage: 400V (RMS)

Multi-Function Process Calibrator
Specifications

Measurement-Temperature

RANGE	ACCURACY	RESOLUTION
-50°C ~ 1300°C	±0.3%+1°C	0.1°C

Source-Voltage

RANGE	ACCURACY	RESOLUTION
100.000mV DC	0.025%+0.03%	1μ V
5.0000V DC	0.025%+0.02%	100μ V
15.000V DC	0.025%+0.02%	1mV

Step time: 1 ~ 99

Step Cycle: 1 ~ 99s

Accuracy is given as ± (% of reading +% of range)

Source-Current

RANGE	ACCURACY	RESOLUTION
25.000mA	0.02%+0.02%	1μ A

Accuracy is given as ± (% of reading +% of range)

Multi-Function Process Calibrator
Accessory, Others

Source-Frequency

RANGE	ACCURACY	RESOLUTION
20Hz ~ 5000Hz	0.02%	0.01Hz ~ 0.1Hz

18 standard frequency: 5kHz, 2500Hz, 2000Hz, 1250Hz, 1000Hz, 800Hz, 500Hz, 400Hz, 250Hz, 200Hz, 160Hz, 100Hz, 80Hz, 60Hz, 50Hz, 40Hz, 25Hz, 20Hz。

Accessory

Users Manual		1
Batteries	1.5V AA	8
Batteries	9V Alkaline 1604A 6LR61	1
Thermocouple	(TYPE K)	1
Test Leads		1
Rs232 Cable		1
PC Data Record Software		1
Carry Case		1

Others

1. Do not use abrasives or solvents on the meter, use a damp cloth mild detergent only.
2. If any faults or abnormalities are observed, the meter can not be used any more and it has to be checked out.